

User Manual

Hybrid 1KW-5KW INVERTER / CHARGER

Table Of Contents

ABOUT THIS MANUAL	1
Purpose.....	1
Scope.....	1
SAFETY INSTRUCTIONS	1
INTRODUCTION	2
Product Overview.....	3
INSTALLATION	4
Unpacking and Inspection.....	4
Preparation	4
Mounting the Unit.....	4
Battery Connection	5
AC Input/Output Connection.....	6
PV Connection	7
Communication Connection.....	8
Dry Contact Signal.....	8
OPERATION	9
Power ON/OFF	9
Operation and Display Panel	9
LCD Display Icons	10
LCD Setting.....	11
Display Setting	19
Operating Mode Description	21
SPECIFICATIONS	25
TROUBLE SHOOTING	26

ABOUT THIS MANUAL

Purpose

This manual describes the assembly, installation, operation and troubleshooting of this unit. Please read this manual carefully before installations and operations. Keep this manual for future reference.

Scope

This manual provides safety and installation guidelines as well as information on tools and wiring.

SAFETY INSTRUCTIONS



WARNING: This chapter contains important safety and operating instructions. Read and keep this manual for future reference.

1. Before using the unit, read all instructions and cautionary markings on the unit, the batteries and all appropriate sections of this manual.
2. **CAUTION** --To reduce risk of injury, charge only deep-cycle lead acid type rechargeable batteries. Other types of batteries may burst, causing personal injury and damage.
3. Do not disassemble the unit. Take it to a qualified service center when service or repair is required. Incorrect re-assembly may result in a risk of electric shock or fire.
4. To reduce risk of electric shock, disconnect all wirings before attempting any maintenance or cleaning. Turning off the unit will not reduce this risk.
5. **CAUTION** – Only qualified personnel can install this device with battery.
6. **NEVER** charge a frozen battery.
7. For optimum operation of this inverter/charger, please follow required spec to select appropriate cable size. It's very important to correctly operate this inverter/charger.
8. Be very cautious when working with metal tools on or around batteries. A potential risk exists to drop a tool to spark or short circuit batteries or other electrical parts and could cause an explosion.
9. Please strictly follow installation procedure when you want to disconnect AC or DC terminals. Please refer to INSTALLATION section of this manual for the details.
10. Fuses (3 pieces of 40A, 32VDC for 1KW, 4 pieces of 40A, 32VDC for 2KW and 1 piece of 200A, 58VDC for 3KW, 4KW and 5KW) are provided as over-current protection for the battery supply.
11. GROUNDING INSTRUCTIONS -This inverter/charger should be connected to a permanent grounded wiring system. Be sure to comply with local requirements and regulation to install this inverter.
12. NEVER cause AC output and DC input short circuited. Do NOT connect to the mains when DC input short circuits.
13. **Warning!!** Only qualified service persons are able to service this device. If errors still persist after following troubleshooting table, please send this inverter/charger back to local dealer or service center for maintenance.

INTRODUCTION

This hybrid PV inverter can provide power to connected loads by utilizing PV power, utility power and battery power.

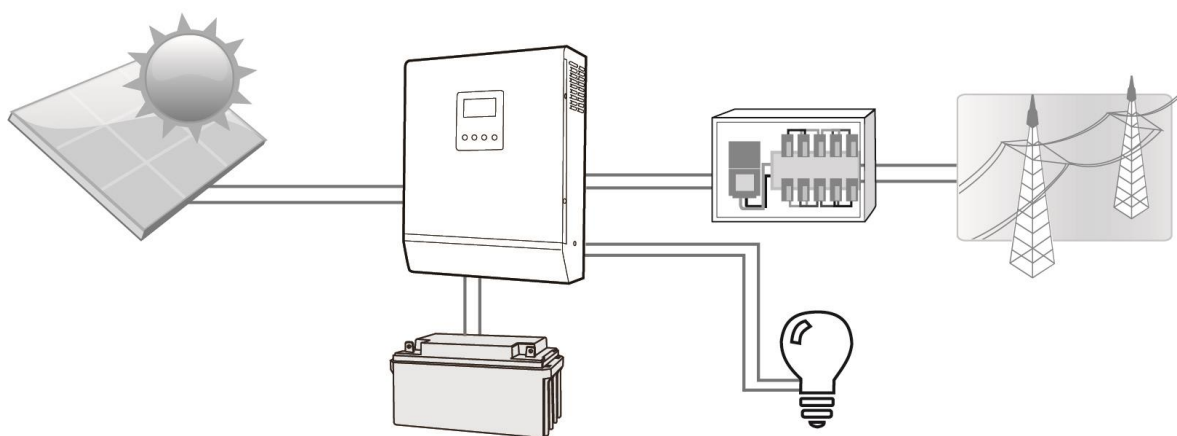
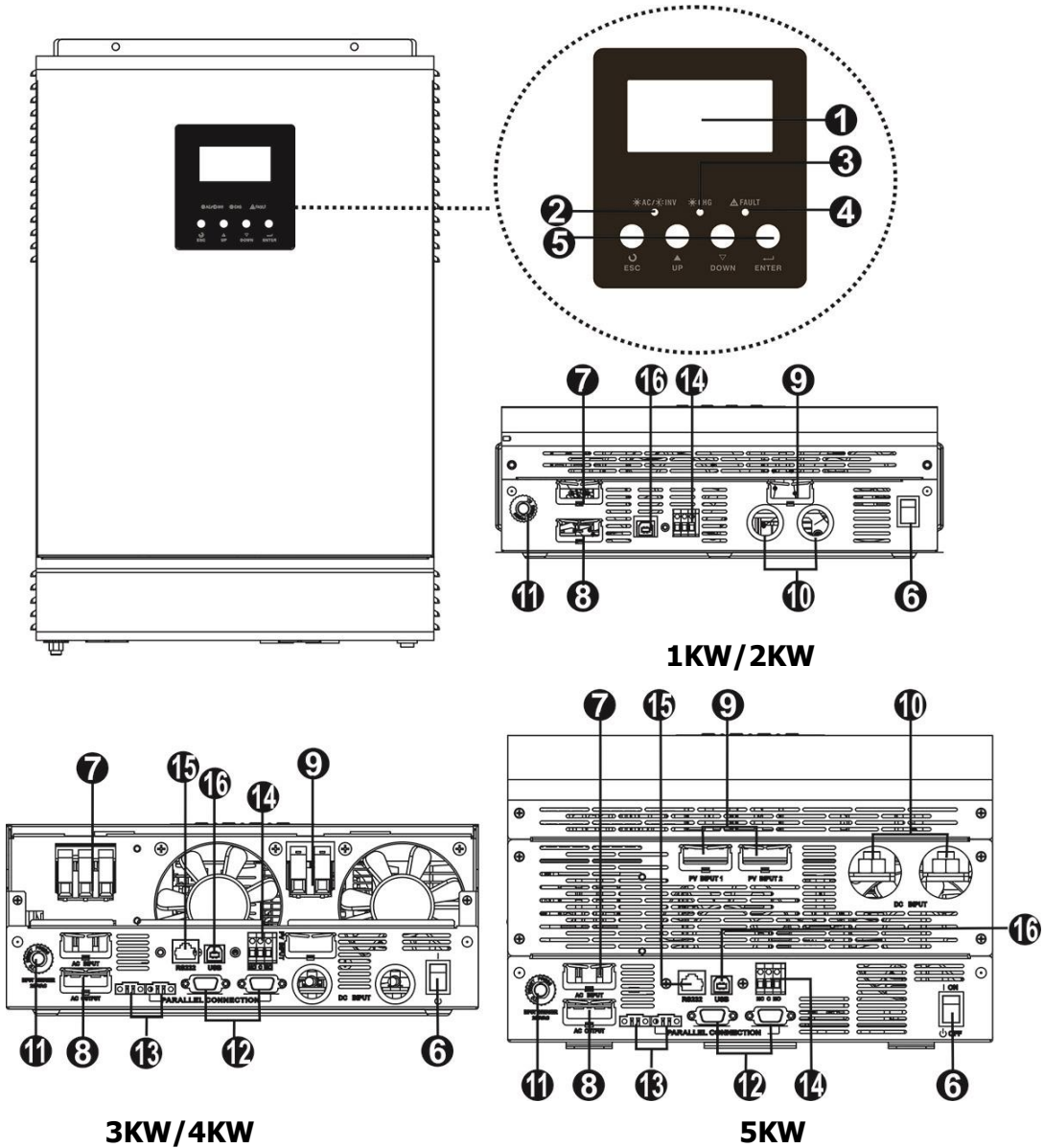

Figure 1 Basic hybrid PV System Overview

Depending on different power situations, this hybrid inverter is designed to generate continuous power from PV solar modules (solar panels), battery, and the utility. When MPP input voltage of PV modules is within acceptable range (see specification for the details), this inverter is able to generate power to feed the grid (utility) and charge battery. Galvanic isolation designed between PV/DC and AC output, so that user could connect any type of PV array to this Hybrid inverter. See Figure 1 for a simple diagram of a typical solar system with this hybrid inverter.

Product Overview



NOTE: For parallel model installation and operation, please check separate parallel installation guide for the details.

- | | |
|---|----------------------------------|
| 1. LCD display | 9. PV connectors |
| 2. Status indicator | 10. Battery connectors |
| 3. Charging indicator | 11. Circuit breaker |
| 4. Fault indicator | 12. Parallel communication cable |
| 5. Function buttons | 13. Current sharing cable |
| 6. Power on/off switch | 14. Dry contact |
| 7. Grid connectors | 15. RS-232 communication port |
| 8. AC output connectors (Load connection) | 16. USB communication port |

INSTALLATION

Unpacking and Inspection

Before installation, please inspect the unit. Be sure that nothing inside the package is damaged. You should have received the following items inside of package:

- The unit x 1, User manual x 1, Communication cable x 1, Software CD x 1

Preparation

Before connecting all wirings, please take off bottom cover by removing two screws as shown below.

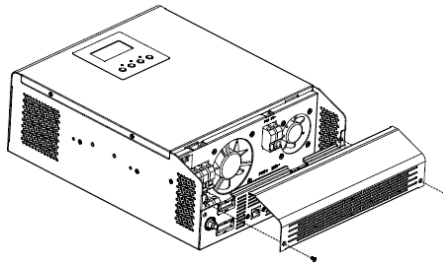

Mounting the Unit

Consider the following points before selecting where to install:

- Do not mount the inverter on flammable construction materials.
- Mount on a solid surface
- Install this inverter at eye level in order to allow the LCD display to be read at all times.
- The ambient temperature should be between 0°C and 55°C to ensure optimal operation.
- The recommended installation position is to be adhered to the wall vertically.
- Be sure to keep other objects and surfaces as shown in the right diagram to guarantee sufficient heat dissipation and to have enough space for removing wires.

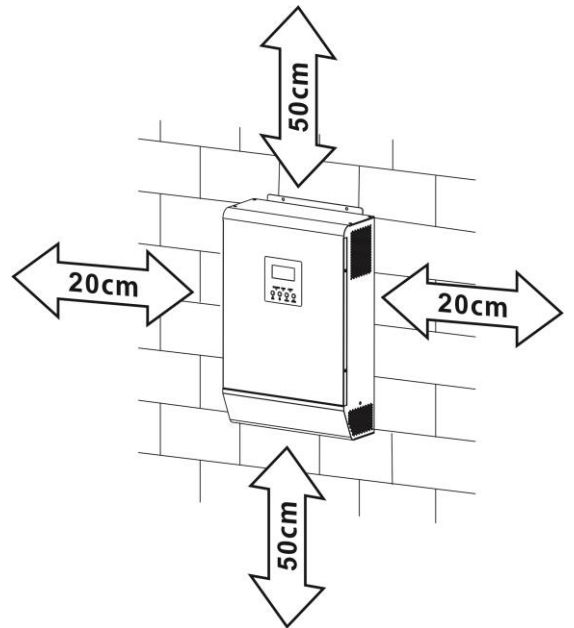

SUITABLE FOR MOUNTING ON CONCRETE OR OTHER NON-COMBUSTIBLE SURFACE ONLY.

Install the unit by screwing three screws. It's recommended to use M4 or M5 screws.

1KW-4KW model

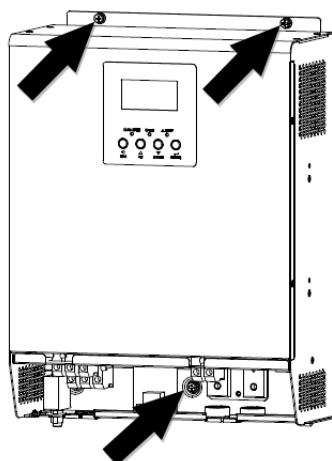

5KW model

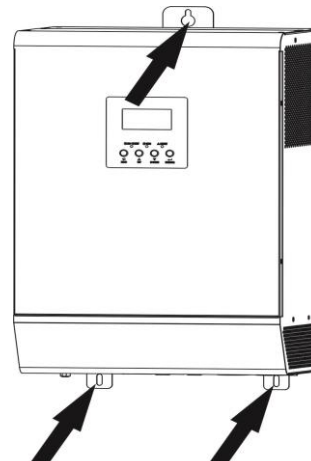

Battery Connection

CAUTION: For safety operation and regulation compliance, it's requested to install a separate DC over-current protector or disconnect device between battery and inverter. It may not be requested to have a disconnect device in some applications, however, it's still requested to have over-current protection installed. Please refer to typical amperage in below table as required fuse or breaker size.

WARNING! All wiring must be performed by a qualified personnel.

WARNING! It's very important for system safety and efficient operation to use appropriate cable for battery connection. To reduce risk of injury, please use the proper recommended cable and terminal size as below.

Ring terminal:

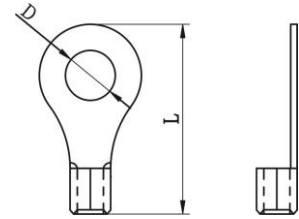

Recommended battery cable and terminal size:

Model	Typical Amperage	Battery Capacity	Wire Size	Ring Terminal			Torque Value
				Cable mm ²	Dimensions		
					D (mm)	L (mm)	
1KW, 2KW, 3KW, 4KW	140A	200AH	1*2AWG	38	6.4	39.2	2~3 Nm
			2*6AWG	28	6.4	33.2	
5KW	180A	600AH	2*4AWG	44	10.5	55	10~12 Nm

Please follow below steps to implement battery connection:

1. Assemble battery ring terminal based on recommended battery cable and terminal size.
2. Insert the ring terminal of battery cable flatly into battery connector of inverter and make sure the bolts are tightened with torque of 2-3 Nm. Make sure polarity at both the battery and the inverter/charge is correctly connected and ring terminals are tightly screwed to the battery terminals.

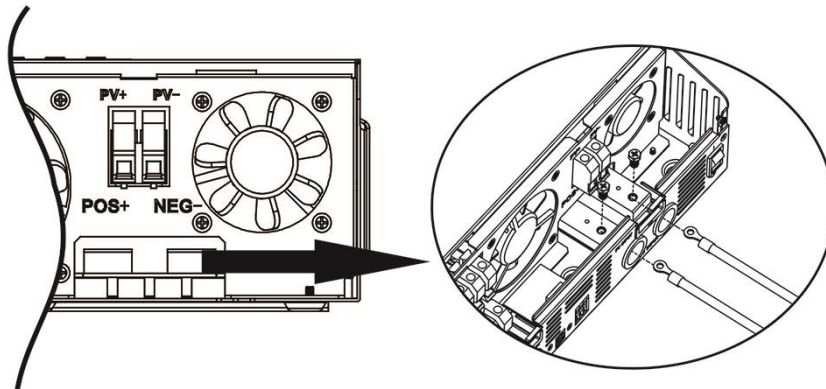

WARNING: Shock Hazard
 Installation must be performed with care due to high battery voltage in series.

CAUTION!! Do not place anything between the flat part of the inverter terminal and the ring terminal. Otherwise, overheating may occur.
CAUTION!! Do not apply anti-oxidant substance on the terminals before terminals are connected tightly.
CAUTION!! Before making the final DC connection or closing DC breaker/disconnector, be sure positive (+) must be connected to positive (+) and negative (-) must be connected to negative (-).

AC Input/Output Connection

CAUTION!! Before connecting to AC input power source, please install a **separate** AC breaker between inverter and AC input power source. This will ensure the inverter can be securely disconnected during maintenance and fully protected from over current of AC input.

CAUTION!! There are two terminal blocks with "IN" and "OUT" markings. Please do NOT mis-connect input and output connectors.

WARNING! All wiring must be performed by a qualified personnel.

WARNING! It's very important for system safety and efficient operation to use appropriate cable for AC input connection. To reduce risk of injury, please use the proper recommended cable size as below.

Suggested cable requirement for AC wires

Model	Gauge	Torque Value
1KW	16 AWG	0.5~ 0.6 Nm
2KW	14 AWG	0.8~ 1.0 Nm
3KW	12 AWG	1.2~ 1.6 Nm
4KW	10 AWG	1.4~ 1.6Nm
5KW	10 AWG	1.4~ 1.6Nm

Please follow below steps to implement AC input/output connection:

1. Before making AC input/output connection, be sure to open DC protector or disconnecter first.
2. Remove insulation sleeve 10mm for six conductors. And shorten phase L and neutral conductor N 3 mm.
3. Insert AC input wires according to polarities indicated on terminal block and tighten the terminal screws. Be sure to connect PE protective conductor (⊕) first.

⊕ → **Ground (yellow-green)**
L → **LINE (brown or black)**
N → **Neutral (blue)**

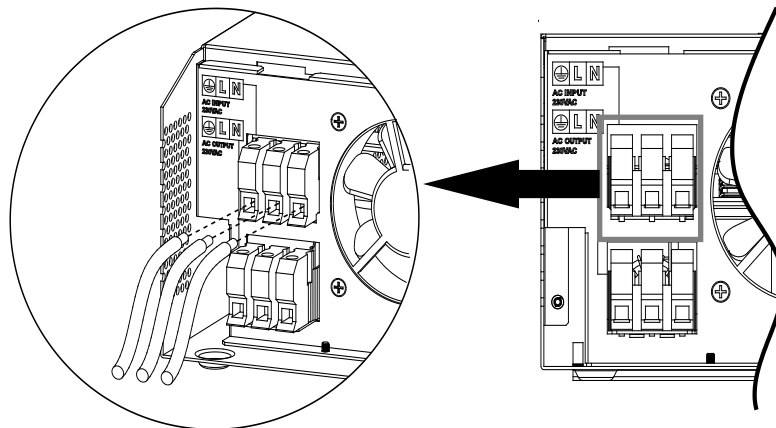

WARNING:

Be sure that AC power source is disconnected before attempting to hardwire it to the unit.

4. Then, insert AC output wires according to polarities indicated on terminal block and tighten terminal screws. Be sure to connect PE protective conductor (⊕) first.

⊕ → **Ground (yellow-green)**
L → **LINE (brown or black)**
N → **Neutral (blue)**

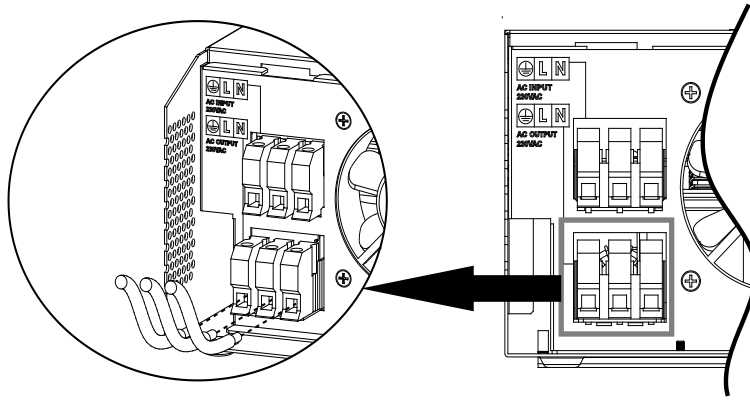

5. Make sure the wires are securely connected.

CAUTION: Important

Be sure to connect AC wires with correct polarity. If L and N wires are connected reversely, it may cause utility short-circuited when these inverters are worked in parallel operation.

CAUTION: Appliances such as air conditioner are required at least 2~3 minutes to restart because it's required to have enough time to balance refrigerant gas inside of circuits. If a power shortage occurs and recovers in a short time, it will cause damage to your connected appliances. To prevent this kind of damage, please check manufacturer of air conditioner if it's equipped with time-delay function before installation. Otherwise, this inverter/charger will trig overload fault and cut off output to protect your appliance but sometimes it still causes internal damage to the air conditioner.

PV Connection

CAUTION: Before connecting to PV modules, please install **separately** a DC circuit breaker between inverter and PV modules.

WARNING! All wiring must be performed by a qualified personnel.

WARNING! It's very important for system safety and efficient operation to use appropriate cable for PV module connection. To reduce risk of injury, please use the proper recommended cable size as below.

Model		Typical Amperage	Cable Size	Torque
1KW, 2KW, 3KW, 4KW		80A	6AWG	2.0~2.4Nm
5KW	PV 1	60A	8AWG	2.0~2.4Nm
	PV 2	60A	8AWG	2.0~2.4Nm

PV Module Selection:

When selecting proper PV modules, please be sure to consider below parameters:

1. Open circuit Voltage (Voc) of PV modules not exceeds max. PV array open circuit voltage of inverter.
2. Open circuit Voltage (Voc) of PV modules should be higher than min. battery voltage.

Solar Charging Mode					
INVERTER MODEL	1KW	2KW	3KW	4KW	5KW
Max. PV Array Open Circuit Voltage	145Vdc				
PV Array MPPT Voltage Range	15~115Vdc	30~115Vdc	60~115Vdc		
MPP Number	1	1	1	1	2

Please follow below steps to implement PV module connection:

1. Remove insulation sleeve 10 mm for positive and negative conductors.
2. Check correct polarity of connection cable from PV modules and PV input connectors. Then, connect positive pole (+) of connection cable to positive pole (+) of PV input connector. Connect negative pole (-) of connection cable to negative pole (-) of PV input connector.

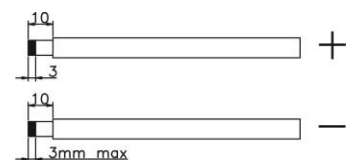

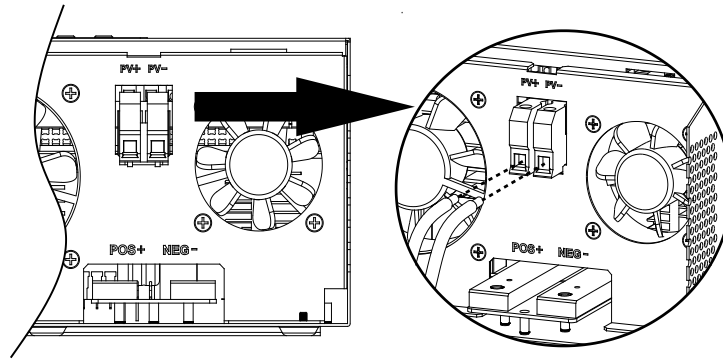

Recommended PV module Configuration

PV Module Spec. (reference)	Inverter Model	SOLAR INPUT 1	SOLAR INPUT 2	Q'ty of modules
- 250Wp - Vmp: 30.7Vdc - Imp: 8.15A - Voc: 37.4Vdc - Isc: 8.63A - Cells: 60	1KW	2S2P	N/A	4pcs
	2KW	2S4P	N/A	8pcs
	3KW, 4KW	2S8P	N/A	16pcs
		3S5P	N/A	15pcs
	5KW	2S6P	2S6P	24pcs
		3S4P	3S4P	24pcs

Communication Connection

Please use supplied communication cable to connect to inverter and PC. Insert bundled CD into a computer and follow on-screen instruction to install the monitoring software. For the detailed software operation, please check user manual of software inside of CD.

Dry Contact Signal

There is one dry contact (3A/250VAC) available on the rear panel. It could be used to deliver signal to external device when battery voltage reaches warning level.

Unit Status	Condition		Dry contact port: 		
			NC & C	NO & C	
Power Off	Unit is off and no output is powered.		Close	Open	
Power On	Output is powered from Utility.		Close	Open	
	Output is powered from Battery or Solar.	Program 01 set as SUB	Battery voltage < Low DC warning voltage	Open	Close
			Battery voltage > Setting value in Program 13 or battery charging reaches floating stage	Close	Open
	Program 01 is set as SBU		Battery voltage < Setting value in Program 12	Open	Close
		Battery voltage > Setting value in Program 13 or battery charging reaches floating stage	Close	Open	

OPERATION

Power ON/OFF

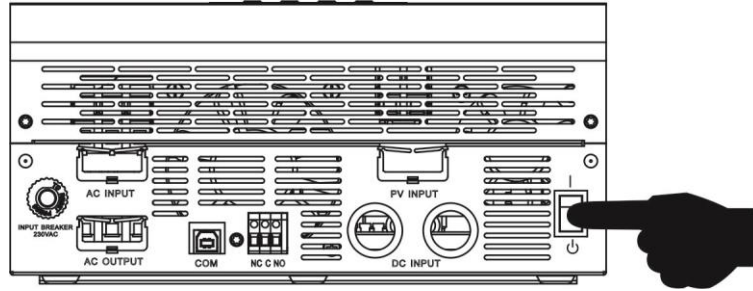

Once the unit has been properly installed and the batteries are connected well, simply press On/Off switch (located on the button of the case) to turn on the unit.

Operation and Display Panel

The operation and display panel, shown in below chart, is on the front panel of the inverter. It includes three indicators, four function keys and a LCD display, indicating the operating status and input/output power information.

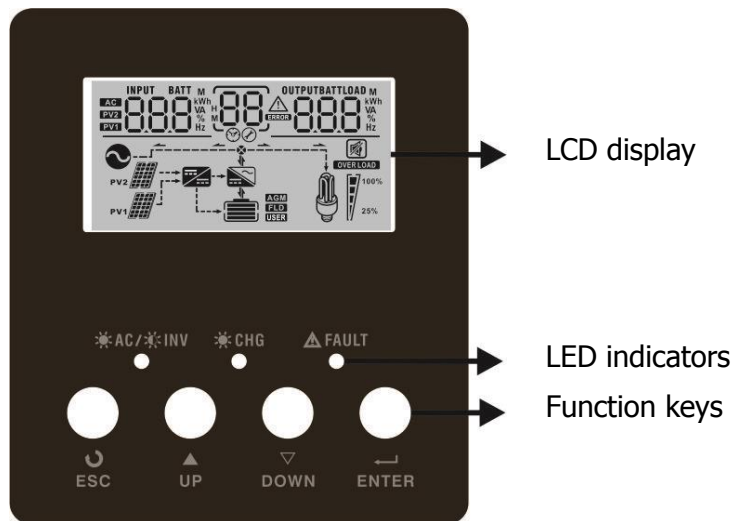

LED Indicator

LED Indicator		Messages	
☀ AC / ☀ INV	Green	Solid On	Output is powered by utility in Line mode.
		Flashing	Output is powered by battery or PV in battery mode.
☀ CHG	Green	Solid On	Battery is fully charged.
		Flashing	Battery is charging.
⚠ FAULT	Red	Solid On	Fault occurs in the inverter.
		Flashing	Warning condition occurs in the inverter.





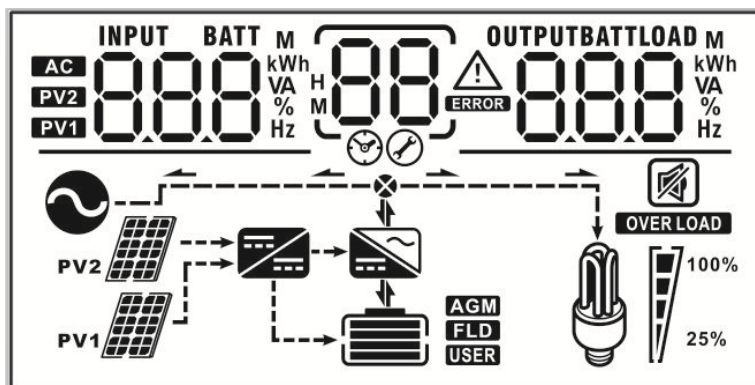

Function Keys

Function Key	Description
ESC	To exit setting mode
UP	To go to previous selection
DOWN	To go to next selection
ENTER	To confirm the selection in setting mode or enter setting mode

LCD Display Icons



Icon	Function							
Input source information								
	Indicates the AC input							
	Indicates the 1 st PV panel input							
	Indicates the 2 nd PV panel input							
Left digital display information								
	Indicate input voltage, input frequency, battery voltage, PV1 voltage, PV2 voltage, charger current							
Middle digital display information								
	Indicates the setting programs.							
	Indicates the warning and fault codes. Warning: Flashing with warning code Fault: display with fault code							
Right digital display information								
	Indicate the output voltage, output frequency, load percent, load VA, load W, PV1 charger power, PV2 charger power, DC discharging current.							
Battery information								
	Indicates battery level by 0-24%, 25-49%, 50-74% and 75-100% and charging status.							
	Indicates the battery type: AGM, Flooded or User-defined battery.							
Load information								
	Indicates overload.							
	Indicates the load level by 0-24%, 25-50%, 50-74%, and 75-100%.							
	<table border="1"> <tr> <td>0%~25%</td> <td>25%~50%</td> <td>50%~75%</td> <td>75%~100%</td> </tr> <tr> <td></td> <td></td> <td></td> <td></td> </tr> </table>	0%~25%	25%~50%	50%~75%	75%~100%			
0%~25%	25%~50%	50%~75%	75%~100%					







Mode operation information	
	Indicates unit connects to the mains.
	Indicates unit connects to the 1 st PV panel
	Indicates unit connects to the 2 nd PV panel
	Indicates the solar charger is working
	Indicates the DC/AC inverter circuit is working.
Mute operation	
	Indicates unit alarm is disabled.

LCD Setting

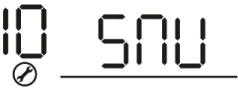

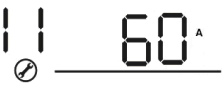
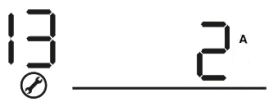

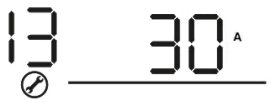

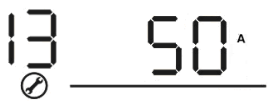
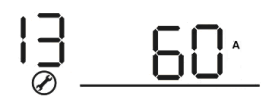

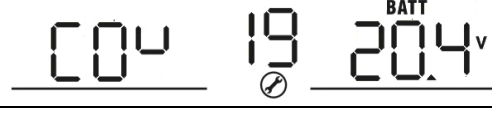
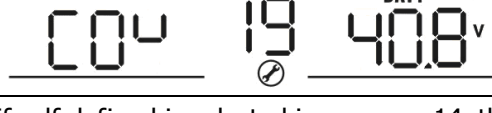
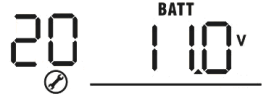

After pressing and holding ENTER button for 3 seconds, the unit will enter setting mode. Press "UP" or "DOWN" button to select setting programs. And then, press "ENTER" button to confirm the selection or ESC button to exit.

Program	Description	Selectable option
00	Exit setting mode	Escape 00 ESC
01	Output source priority selection	01 SUB Solar energy provides power to the loads as first priority. If solar energy is not sufficient to power all connected loads, Utility energy will supply power to the loads at the same time.
		01 SBU Solar energy provides power to the loads as first priority. If solar energy is not sufficient to power all connected loads, battery energy will supply power to the loads at the same time. Utility provides power to the loads only when battery voltage drops to either low-level warning voltage or the setting point in program 20 or solar and battery is not sufficient.

02	AC input voltage range	Appliances (default) 02 <u>APL</u>	If selected, acceptable AC input voltage range will be within 90-280VAC.
		UPS 02 <u>UPS</u>	If selected, acceptable AC input voltage range will be within 170-280VAC.
03	Output voltage	220Vac 03 <u>220^v</u>	230V (Default) 03 <u>230^v</u>
		240Vac 03 <u>240^v</u>	
04	Output frequency	50Hz (default) 04 <u>50^{Hz}</u>	60Hz 04 <u>60^{Hz}</u>
05	Solar supply priority	05 <u>BLU</u>	Solar energy provides power to charge battery as first priority.
		05 <u>LBU</u>	Solar energy provides power to the loads as first priority.
06	Overload bypass: When enabled, the unit will transfer to line mode if overload occurs in battery mode.	Bypass disable (default) 06 <u>BYD</u>	Bypass enable 06 <u>BYE</u>
07	Auto restart when overload occurs	Restart disable (default) 07 <u>LRD</u>	Restart enable 07 <u>LRE</u>
08	Auto restart when over temperature occurs	Restart disable (default) 08 <u>TRD</u>	Restart enable 08 <u>TRE</u>
09	Solar or battery energy feed to grid configuration	09 <u>GRD</u>	Solar or battery energy feed to grid disable.
		09 <u>GRE</u>	Solar or battery energy feed to grid enable.

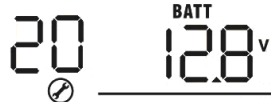
10	Charger source priority: To configure charger source priority	If this inverter/charger is working in Line, Standby or Fault mode, charger source can be programmed as below:	
		Solar first 	Solar energy will charge battery as first priority. Utility will charge battery only when solar energy is not available.
		Solar and Utility (default) 	Solar energy and utility will charge battery at the same time.
		Only Solar 	Solar energy will be the only charger source no matter utility is available or not.
		If this inverter/charger is working in Battery mode or Power saving mode, only solar energy can charge battery. Solar energy will charge battery if it's available and sufficient.	
11	Maximum charging current: To configure total charging current for solar and utility chargers. (Max. charging current = utility charging current + solar charging current)	60A (default) 	For 1KW~4KW models, setting range is from 10A to 140A. For 5KW model, setting range is from 10A to 180A. Increment of each click is 10A.
13	Maximum utility charging current	2A 	10A 
		20A 	30A (default) 
		40A 	50A 
		60A 	

14	Battery type	AGM (default) 14 AGM	Flooded 14 FLD
		User-Defined 14 USE	If "User-Defined" is selected, battery charge voltage and low DC cut-off voltage can be set up in program 17, 18 and 19.
17	Bulk charging voltage (C.V voltage)	12V model default setting: 14.1V CU 17 BATT 14.1v	
		24V model default setting: 28.2V CU 17 BATT 28.2v	
		48V model default setting: 56.4V CU 17 BATT 56.4v	
		If self-defined is selected in program 14, this program can be set up. Setting range is from 12.0V to 15.3V for 12Vdc model, 24.0V to 30.6V for 24Vdc model and 48.0V to 58.4V for 48Vdc model. Increment of each click is 0.1V.	
18	Floating charging voltage	12V model default setting: 13.5V FLU 18 BATT 13.5v	
		24V model default setting: 27.0V FLU 18 BATT 27.0v	
		48V model default setting: 54.0V FLU 18 BATT 54.0v	
		If self-defined is selected in program 14, this program can be set up. Setting range is from 12.0V to 15.3V for 12Vdc model, 24.0V to 30.6V for 24Vdc model and 48.0V to 58.4V for 48Vdc model. Increment of each click is 0.1V.	

19	Low DC cut off battery voltage setting	12V model default setting: 10.2V 	
		24V model default setting: 20.4V 	
		48V model default setting: 40.8V 	
		If self-defined is selected in program 14, this program can be set up. Setting range is from 10.2V to 12.0V for 12Vdc model, 20.4V to 24V for 24Vdc model and 40.8V to 48.0V for 48Vdc model. Increment of each click is 0.1V. Low DC cut-off voltage will be fixed to setting value no matter what percentage of load is connected.	
20	Battery stop discharging voltage when grid is available	Available options for 12V models:	
		11.0V 	11.3V 
		11.5V (default) 	11.8V 
		12.0V 	12.3V 
		12.5V 	12.8V 
		Available options for 24V models:	
		22.0V 	22.5V 
		23.0V (default) 	23.5V 

		24.0V 20 ^{BATT} 24.0v	24.5V 20 ^{BATT} 24.5v
		25.0V 20 ^{BATT} 25.0v	25.5V 20 ^{BATT} 25.5v
		Available options for 48V models:	
		44.0V 20 ^{BATT} 44v	45.0V 20 ^{BATT} 45v
		46.0V (default) 20 ^{BATT} 46v	47.0V 20 ^{BATT} 47v
		48.0V 20 ^{BATT} 48v	49.0V 20 ^{BATT} 49v
		50.0V 20 ^{BATT} 50v	51.0V 20 ^{BATT} 51v
21	Battery stop charging voltage when grid is available	Available options for 12V models:	
		Battery fully charged 21 ^{BATT} FUL	12.0V 21 ^{BATT} 12.0v
		12.3V 21 ^{BATT} 12.3v	12.5V 21 ^{BATT} 12.5v
		12.8V 21 ^{BATT} 12.8v	13.0V 21 ^{BATT} 13.0v
		13.3V 21 ^{BATT} 13.3v	13.5V (default) 21 ^{BATT} 13.5v
		13.8V 21 ^{BATT} 13.8v	14.0V 21 ^{BATT} 14.0v

		14.3V 21 ^{BATT} 14.3 _v	14.5V 21 ^{BATT} 14.5 _v
Available options for 24V models:			
	Battery fully charged	21 ^{BATT} FUL	24V 21 ^{BATT} 24.0 _v
	24.5V	21 ^{BATT} 24.5 _v	25V 21 ^{BATT} 25.0 _v
	25.5V	21 ^{BATT} 25.5 _v	26V 21 ^{BATT} 26.0 _v
	26.5V	21 ^{BATT} 26.5 _v	27V (default) 21 ^{BATT} 27.0 _v
	27.5V	21 ^{BATT} 27.5 _v	28V 21 ^{BATT} 28.0 _v
	28.5V	21 ^{BATT} 28.5 _v	29V 21 ^{BATT} 29.0 _v
Available options for 48V models:			
	Battery fully charged	21 ^{BATT} FUL	48.0V 21 ^{BATT} 48.0 _v
	49.0V	21 ^{BATT} 49.0 _v	50.0V 21 ^{BATT} 50.0 _v
	51.0V	21 ^{BATT} 51.0 _v	52.0V 21 ^{BATT} 52.0 _v
	53.0V	21 ^{BATT} 53.0 _v	54.0V 21 ^{BATT} 54.0 _v
	55.0V		56.0V

		21 ^{BATT} 55.0 _v	21 ^{BATT} 56.0 _v
		57.0V 21 ^{BATT} 57.0 _v	58.0V 21 ^{BATT} 58.0 _v
22	Auto return to default display screen	Return to default display screen (default) 22 ^{ESP}	If selected, no matter how users switch display screen, it will automatically return to default display screen (Input voltage /output voltage) after no button is pressed for 1 minute.
		Stay at latest screen 22 ^{HEP}	If selected, the display screen will stay at latest screen user finally switches.
23	Backlight control	Backlight on (default) 23 ^{LON}	Backlight off 23 ^{LOF}
24	Alarm control	Alarm on (default) 24 ^{6ON}	Alarm off 24 ^{6OF}
25	Beeps while primary source is interrupted	Alarm on (default) 25 ^{AON}	Alarm off 25 ^{AOF}
27	Record Fault code	Record enable(default) 27 ^{FEN}	Record disable 27 ^{FDS}
28	AC output mode *This setting is only available when the inverter is in standby mode (Switch off).	28 ^{OUTPUT} 510	28 ^{OUTPUT} PAL
		28 ^{OUTPUT} 3P1	28 ^{OUTPUT} 3P2
		28 ^{OUTPUT} 3P3	

Display Setting



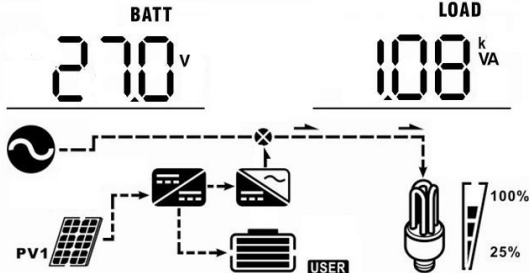
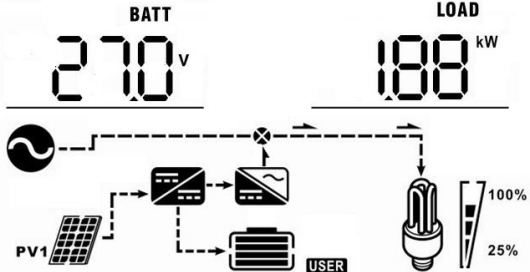
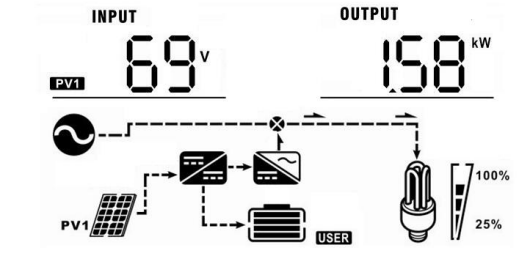
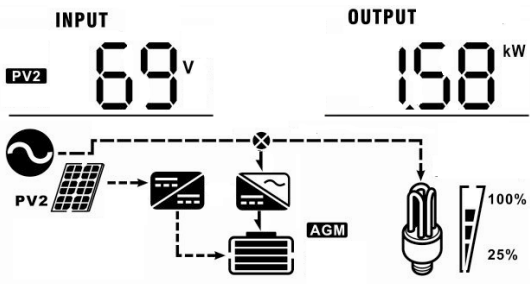
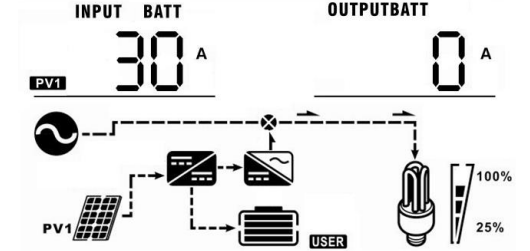

The LCD display information will be switched in turns by pressing "UP" or "DOWN" key. The selectable information is switched as below order: input voltage, input frequency, PV voltage, charging current, battery voltage, output voltage, output frequency, load percentage, load in Watt, load in VA, load in Watt, DC discharging current, main board firmware version and SCC firmware version.

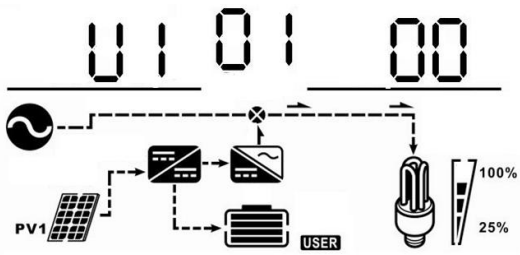
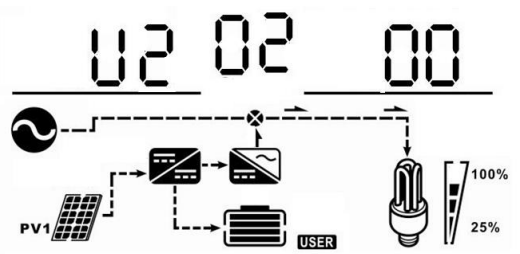



Select item	LCD display
Input voltage and output voltage (Default Display Screen)	<p>Input Voltage=230V, output voltage=230V</p>
Input frequency and output frequency	<p>Input frequency=50.0Hz, output frequency=50.0Hz</p>
Battery voltage and output voltage	<p>Battery Voltage=27.0V, output voltage=230V</p>
Battery voltage and load percentage	<p>Battery Voltage=27.0V, load percentage = 68%</p>

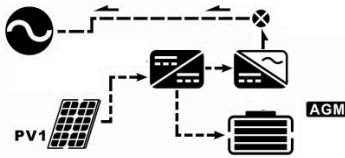

<p>Battery voltage and load in VA</p>	<p>Battery Voltage=27.0V, load in VA=1.08kVA</p> 
<p>Battery voltage and load in Watt</p>	<p>Battery Voltage=27.0V, load in Watt=1.88kW</p> 
<p>PV1 voltage and PV1 charger power</p>	<p>PV1 Voltage=69V, charging power=1.58kW</p> 
<p>PV2 voltage and PV2 charger power</p>	<p>PV2 Voltage=69V, charging power=1.58kW</p> 
<p>Charger current and DC discharging current</p>	<p>Charging current=30A, discharging current=0A</p> 

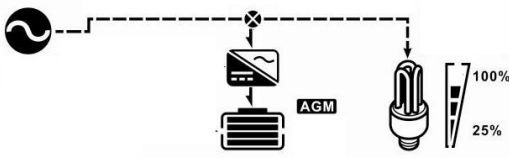
Main board firmware version	Version 00001.00 
SCC firmware version	Version 00002.00 

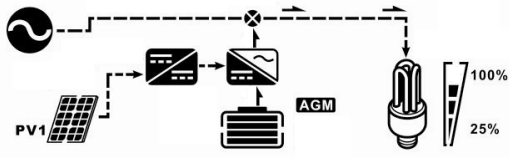
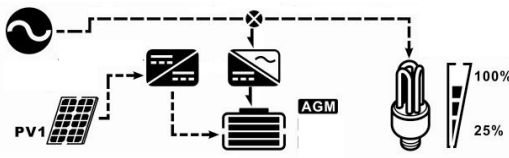

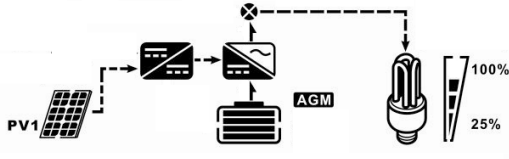

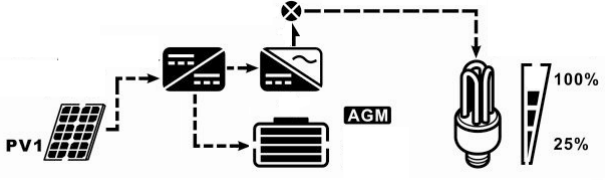
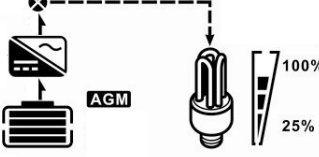
Operating Mode Description

Operating mode	Behaviors	LCD display
<p>Standby mode</p> <p>Note:</p> <p>*Standby mode: The inverter is not turned on yet but at this time, the inverter can charge battery without AC output.</p> <p>*Power saving mode: If enabled, the output of inverter will be off when connected load is pretty low or not detected.</p>	<p>No output power, solar or utility charger available</p>	<p>Battery is charged by utility.</p> 
		<p>Battery is charged by PV energy.</p> 
		<p>Battery is charged by utility and PV energy.</p> 
		<p>Battery is charged by PV energy and feed PV energy to grid.</p> 
		<p>No charging.</p> 

















Line mode	Output power from utility. Charger	Utility charges battery and provides power to load. 
		Utility and battery power provide power to load. 
		PV energy, battery power and utility provide power to load. 
		PV energy and utility charge battery, and utility provides power to load. 
		PV energy charges battery, utility and PV energy provide power to the load. 
		PV energy charges battery, PV energy provides power to the load and feeds remaining energy to the grid. 
Battery mode	Output power from battery or PV	PV energy and battery energy supply power to the load. 

		<p>PV energy charges battery and provides power to the load.</p> 
		<p>Battery provides power to the load.</p> 
<p>Fault mode Note: *Fault mode: Errors are caused by inside circuit error or external reasons such as over temperature, output short circuited and so on.</p>	<p>No output, no charging.</p>	<p>No charging.</p> 

Warning Indicator

Warning Code	Warning Event	Icon flashing
01	Fan locked	
03	Battery over charged	
04	Low battery	
07	Overload	

Faults Reference Code

Fault Code	Fault Event	Icon on
01	Fan locked	
02	Over temperature	
03	Battery voltage is too high	
04	Battery voltage is too low	
05	Output short circuited	
06	Output voltage abnormal	
07	Over load time out	
08	Bus voltage is too high	
09	Bus soft start failed	
51	Over current or surge	
52	Bus voltage is too low	
53	Inverter soft start failed	
55	Over DC offset in AC output	
56	Battery disconnected	
57	Current sensor failed	
58	Output voltage is too low	

SPECIFICATIONS

MODEL	1KW	2KW	3KW	4KW	5KW
RATED OUTPUT POWER	1000 W	2000 W	3000W	4000W	5000W
PV INPUT (DC)					
Max. PV Power	1000W	2000W	4000W	4000W	6000W
Max. PV Array Open Circuit Voltage	145 VDC	145 VDC	145 VDC	145 VDC	145 VDC
MPPT Range @ Operating Voltage	15 VDC~115 VDC	30 VDC~115 VDC	60 VDC~115 VDC	60 VDC~115 VDC	60 VDC~115 VDC
Number of MPP Tracker	1	1	1	1	2
GRID-TIE OPERATION					
GRID OUTPUT (AC)					
Nominal Output Voltage	220/230/240 VAC				
Output Voltage Range	184 - 265 VAC				
Nominal Output Current	4.3A	8.7A	13A	17.4A	21.7A
Power Factor Range	>0.99				
Maximum Conversion Efficiency (DC/AC)	90%				
OFF-GRID, HYBRID OPERATION					
GRID INPUT					
Acceptable Input Voltage Range	90 - 280 VAC or 170 - 280 VAC				
Frequency Range	50 Hz/60 Hz (Auto sensing)				
Rating of AC Transfer Relay	30A		40A		
BATTERY MODE OUTPUT (AC)					
Nominal Output Voltage	220/230/240 VAC				
Output Waveform	Pure Sine Wave				
Efficiency (DC to AC)	93%				
BATTERY & CHARGER					
Nominal DC Voltage	12 VDC	24 VDC	48 VDC	48 VDC	48 VDC
Maximum Charging Current (from Grid)	60A				
Maximum Charging Current (from PV)	80A	80A	80A	80A	120A
Maximum Charging Current	140A	140A	140A	140A	180A
GENERAL					
Dimension, D X W X H (mm)	440 x 300 x 100	440 x 300 x 100	120 x 295 x 468	120 x 295 x 468	190 x 295 x 483
Net Weight (kgs)	8	8	11	11	16
INTERFACE					
Parallel-able	N/A	N/A	Yes	Yes	Yes
External Safety Box (Optional)	Yes				
Communication	USB or RS232/Dry-Contact				
ENVIRONMENT					
Humidity	0 ~ 90% RH (No condensing)				
Operating Temperature	0 to 50°C				

TROUBLE SHOOTING

Problem	LCD/LED/Buzzer	Explanation / Possible cause	What to do
Unit shuts down automatically during startup process.	LCD/LEDs and buzzer will be active for 3 seconds and then complete off.	The battery voltage is too low (<1.91V/Cell)	1. Re-charge battery. 2. Replace battery.
No response after power on.	No indication.	1. The battery voltage is far too low. (<1.4V/Cell) 2. Battery polarity is connected reversed.	1. Check if batteries and the wiring are connected well. 2. Re-charge battery. 3. Replace battery.
Mains exist but the unit works in battery mode.	Input voltage is displayed as 0 on the LCD and green LED is flashing.	Input protector is tripped	Check if AC breaker is tripped and AC wiring is connected well.
	Green LED is flashing.	Insufficient quality of AC power. (Shore or Generator)	1. Check if AC wires are too thin and/or too long. 2. Check if generator (if applied) is working well or if input voltage range setting is correct. (UPS→Appliance)
	Green LED is flashing.	Set "Solar First" as the priority of output source.	Change output source priority to Utility first.
When the unit is turned on, internal relay is switched on and off repeatedly.	LCD display and LEDs are flashing	Battery is disconnected.	Check if battery wires are connected well.
Buzzer beeps continuously and red LED is on.	Fault code 07	Overload error. The inverter is overload 110% and time is up.	Reduce the connected load by switching off some equipment.
	Fault code 05	Output short circuited.	Check if wiring is connected well and remove abnormal load.
		Temperature of internal converter component is over 120°C. (Only available for 1-3KVA models.)	Check whether the air flow of the unit is blocked or whether the ambient temperature is too high.
	Fault code 02	Internal temperature of inverter component is over 100°C.	
	Fault code 03	Battery is over-charged.	Return to repair center.
		The battery voltage is too high.	Check if spec and quantity of batteries are meet requirements.
	Fault code 01	Fan fault	Replace the fan.
	Fault code 06/58	Output abnormal (Inverter voltage below than 190Vac or is higher than 260Vac)	1. Reduce the connected load. 2. Return to repair center
	Fault code 08/09/53/57	Internal components failed.	Return to repair center.
	Fault code 51	Over current or surge.	Restart the unit, if the error happens again, please return to repair center.
	Fault code 52	Bus voltage is too low.	
Fault code 55	Output voltage is unbalanced.		
Fault code 56	Battery is not connected well or fuse is burnt.	If the battery is connected well, please return to repair center.	